

Aerospace Tightening



HERMES 
THE TOOL COMPANY

Kompania Narzędziowa "HERMES" Sp. z o.o.
ul. Sarni Stok 73 a, 43-300 Bielsko-Biała, Polska; tel: +48 33 821 41 90-91
e-mail: biuro@hermestools.eu www.hermestools.eu

**Innovation that
Drives Productivity**

Date January 2015

 **APEX**
TOOL GROUP

- A leading global manufacturer of professional hand and power tools, industrial assembly solutions and services
 - Revenues of \$1.5 billion in 2012 with over 8,500 associates
 - Manufacturing in 27 locations in the Americas, Europe, Asia, Australia
- Diversified sales profile and strong relationships with global OEM's, industrial distributors, and retail customers
 - Commercial operations in over 120 countries
- Strong end-user focused product development culture delivering relevant innovation
 - Over 200 engineering and R&D associates globally
 - Design centers in Germany, France, US, and China
- Globally managed with the Apex Business System (ABS)
 - Enables us to provide innovative solutions with outstanding operational excellence and consistent earnings growth
- Owned by Bain Capital since February 2013

Our Vision

The focused leader in Assembly and Repair Tools delivering smart productivity and smarter results.

Our Mission

To be the first choice for industrial and professional customers by delivering outstanding innovation, productivity solutions and exceptional service around the globe

Our Values



Motor Vehicle

Cleco
mPro4000

LIVEWIRE™

VW
Audi
BMW
DAIMLER
GM
CHRYSLER
CHERY
FAW

Aerospace

Material	Air	Ti	CFRP	Adaptive	Conventional
Time (sec)	27.0	27.0	21.0	77.1	134.7

Standoff: 75" Ti, 50" CFRP, 5"

Time (sec)

Adaptive: Constant clutch off on axis

Conventional

BOEING
BOMBARDIER
AEROLIA
AIRBUS
AN EADS COMPANY
EMBRAER
中国商飞 COMAC
SPIRIT AEROSYSTEMS

General Industry

Run Number

0 50 100

TARGET TORQUE
Cleco TB
OTHERS

GENERAL DYNAMICS
Electric Boat
LUFKIN
GE
GE Energy
Exxon
Hertz Equipment Rental
Howmet Castings
an Alcoa business
ALCOA
Hamilton Sundstrand
A United Technologies Company

Electronics

Digi-Key
CORPORATION, LLC
Farnell
RadioShack Dealer
Newark
ACE
Hardware
TECHNI-TOOL
Precision & Products
LOWE'S
Home Improvement Warehouse
amazon.com

Ergonomics

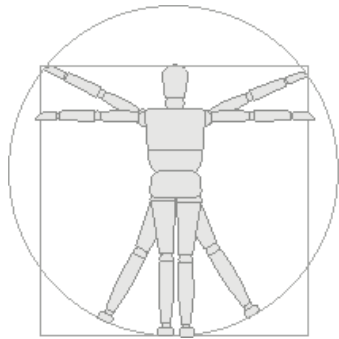

**Contributable Benefits
in Operational Savings
from 10 to 35% +**

Assembly Techniques



**CAPEX savings 15 to 40%
TCO over 3yr life ↓ by 40%**

Intelligent Products



**CAPEX Reduction by 30% +
Operational Benefits ↑ by 30% +
TCO over 3yr life ↓ by 40%**

**Major
automotive
OEMS**

**Operational Reduction
in cost by ≥ 30%**

**Cost Avoidance in Post Sale and
Warranty Campaign Actions
from 10 to 40% less**

**Variable Savings
based on Program
or Combo Prod Selected
Est. 20 to 35% + in Savings**



Commercial



Quality Programs



Service & Support

Broad Operations Footprint



60+ Years in Aerospace



For decades, Aerospace production facilities all over the world have depended on Recoules, Quackenbush, Cleco, Dotco, and Apex products to deliver powerful, reliable, safe, efficient, and user-friendly performance. These products have been designed to bring exceptional value with durability, ergonomics, ease of integration and increased aero build rates in mind.



Advanced drilling equipment, Cutters, and Microstop cages



Pneumatic and Electric Fastening Tools and Systems



Tough, long lasting bits and sockets



Precision Material Removal air tools



Creating durable products for years that last for years.

Aerospace Customers



Equipment

- Fastening
- Controls
- Material Removal
- Drilling
- Soldering
- Accessories
- Quality Assurance
- Torque Management

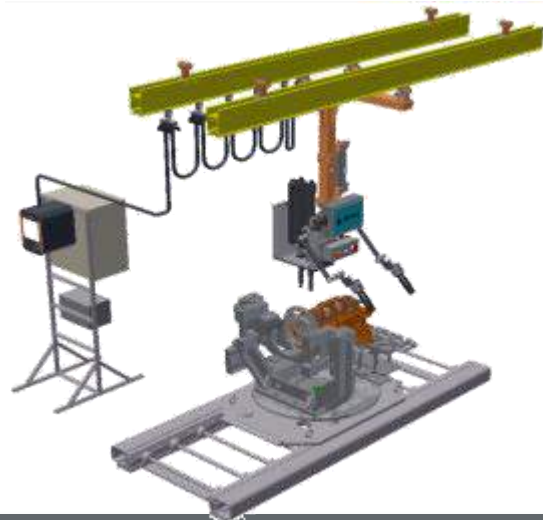

Solutions

- Automated Solutions
- Error Proofing
- Data Management
- Fastening Strategies
- Process Improvements
- Reduced Total Cost of Ownership

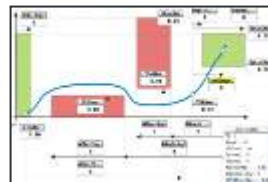

Support

- Project Management
- Turnkey Install & Startup
- Automated Solutions
- Field Service/24-hr hotline
- Repair, Calibration, Optimization Services
- Total Production Maintenance



We enable customers to more easily manufacture their products

- Repair and Maintenance of Pneumatic Tools, Livewire Tools, Cable Tools and I-Wrench
- Spare Parts Center
- Calibration and performance tests incl. certificates according to actual norms
- Service Support





IN-HOUSE REPAIR NETWORK

- USA:** Norwalk, California
Redmond, Washington
Houston, Texas
Auburn Hills, Michigan
York, Pennsylvania
Lexington, South Carolina
- CANADA:** Mississauga, Ontario
- MEXICO:** Queretaro, Mexico
- BRAZIL:** Sorocaba, Brazil
- CHINA:** Shanghai, China
- INDIA:** Pune, India
- ENGLAND:** Staffordshire, UK
- FRANCE:** Ozoir, France
- GERMANY:** Westhausen, Germany
- HUNGARY:** Győr, Hungary



With a full range of tools for every production and maintenance operation, we are your ultimate productivity solutions partner. Our global service network can provide the level of professional repair and maintenance required to keep you up and running. No matter what your current tool repair capabilities are, we can maintain and manage your entire fleet of tools, even those built by other brands. You can rely on our in-house service centers and global distributor-based service network to deliver world-class support.

General Product Review



Assembly Tool Portfolio Overview



ATG has a complete portfolio for all fastening needs.

Pneumatic Tools

Cleco screwdriver



Cleco impact tool



Cleco pulse tool



Cleco pulse tool verifier

DC Tools



Cleco mPRO400GC common controller with error proofing, traceability and reporting

DGD Intelligent Spindle



Cleco Live Wire Tool



DGD current control



TorqueNet

Software

DGD Mini Spindle



DGD conventional spindle



Cleco 18,48 and 67 series tool

Cleco I wrench





Pneumatic Tools



H-Series Pulse Tool

- 45 Years of Pulse Tool Design Evolution
- Built in Germany
- Industry Leading Pulse Unit Design



H-Series Pulse Tool

Quality

- Advanced Design
- Unmatched Repeatability

Reliability

- **Best-In-Class Reliability**
- **~700K pulses cycles between oil changes**

Productivity

- **Best-In-Class Productivity**
- **Highest Repeatability**
- **Fastest rundown time**
- **Operate as low as 4 Bar**



H series Pulse Unit

- Simple to service
- World class reliability
- >700,000 pulse cycles (90,000 rundowns) before oil change
- Dual chamber provides stronger pulses than the competition
- Patented oil reserve system
- Bearing supported output drive

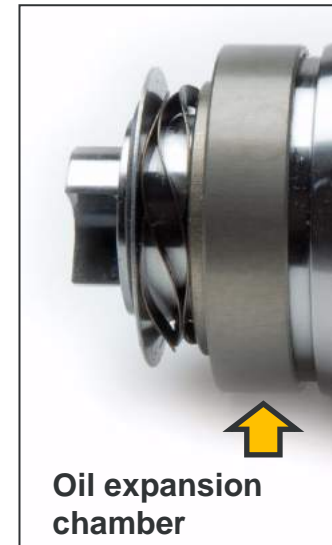

H-Series Options

- Shut-Off
 - 4 - 120 Nm of Torque
- Non Shut-Off
 - 7 - 120 Nm of Torque
- Square Drive
 - 1/4" - 1/2"
- Internal Hex Drive
 - 1/4"



- Air on Top
 - Shut-off/ non shut-off models



Cleco Engineered Pulse Tool System

Cleco[®]



In line tools

- 3-25 NM
- Lever start
- Push to start
- Quiet
- Very low torque relations
- Fast

Non-shut off

- 3-400 nm
- Easy set-up and service
- Adjustable torque control
- Lightweight
- Very low reaction
- Air from top option
- Quiet
- Fast

Shut off

- 3-400 Nm
- World class accuracy
- Easy set up and service
- Air from top option
- Lightweight
- Very low reaction
- Quiet
- Fast

Qualifiers

- Error-proofing process qualifier
- Batch and cycle counting
- I/O for process flow control
- No tool modifications required
- Easy set-up



Cleco Offers a full Array of Parts and Accessories

Product Overview



Accuracy

Lower Cost of Quality

- Industry-leading accuracy reduces costly rework
- Longer time between calibrations

Durability

Lower Cost of Operation

- Designed and tested to over 1 million cycles
- 5-year clutch warranty

Customizability

Higher Productivity

- Torque multiplier compatibility for large structure joints
- Specialty head compatibility for access limited applications
- Over 100 variations, including custom-built configurations

Ergonomics

Higher Productivity

- World-class ergonomics and comfort

19 Series



Design Features

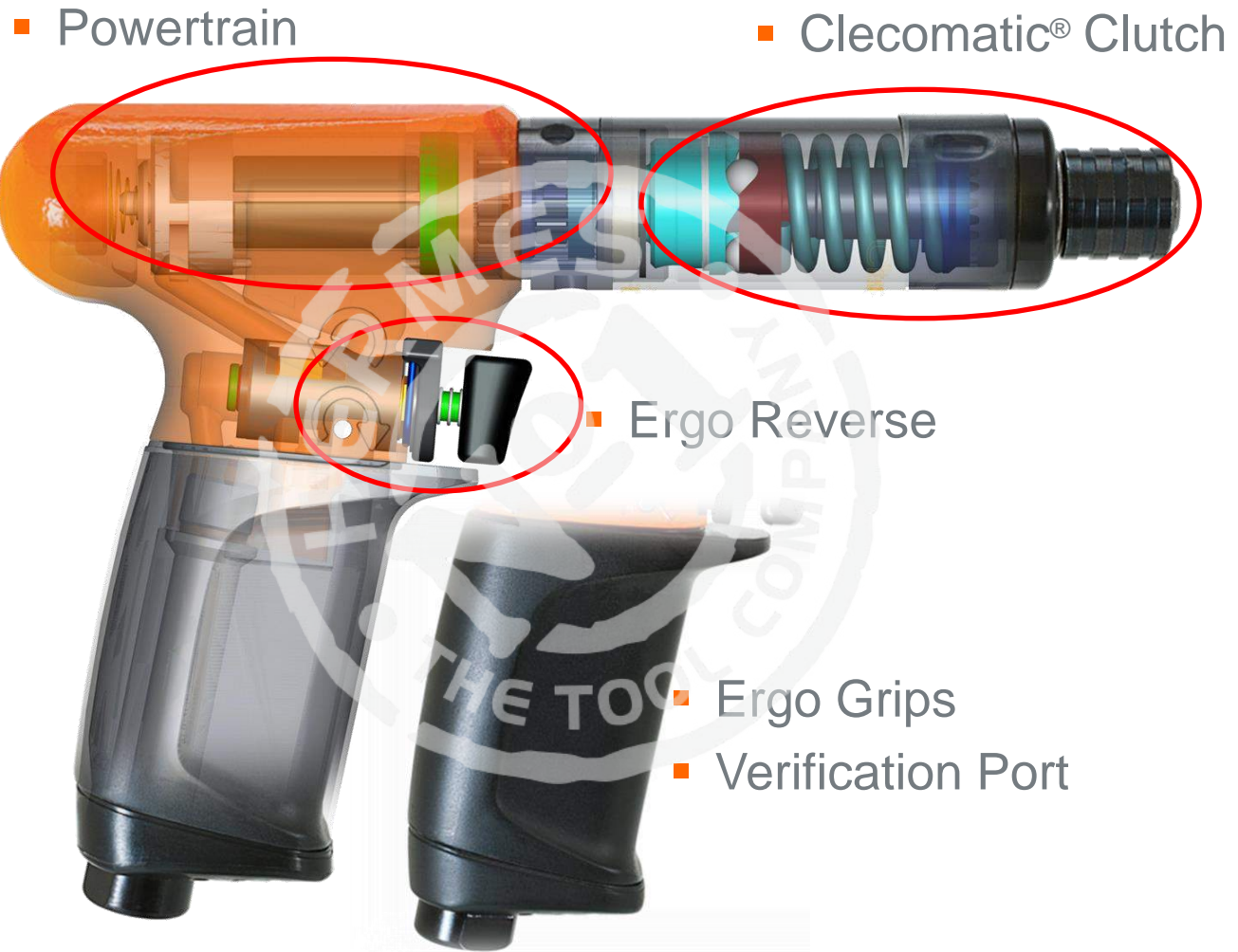

Clecomatic® Clutch - Accuracy and Repeatability

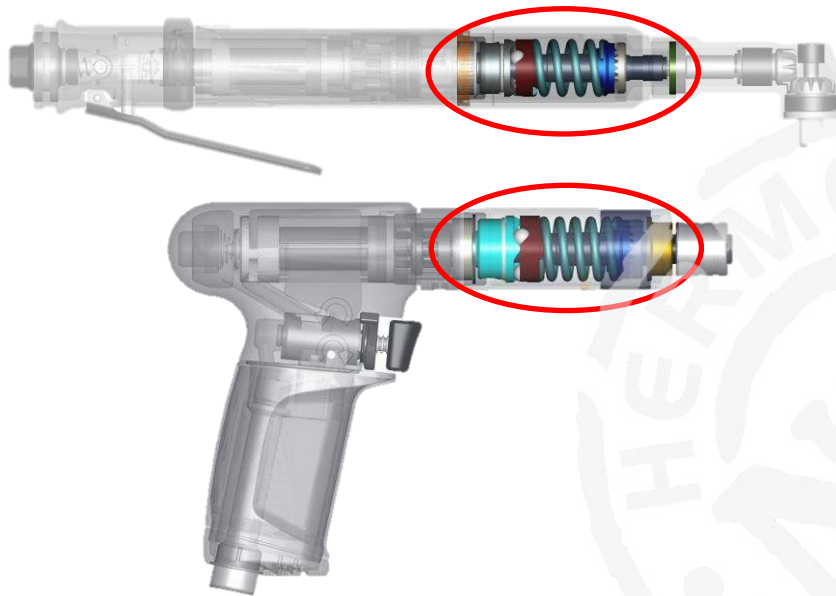

- Industry leading accuracy
- Industry leading repeatability
- Less time between calibration
- Clutch 5 year warranty

19 Series Clecomatic® Clutch vs Competitor A

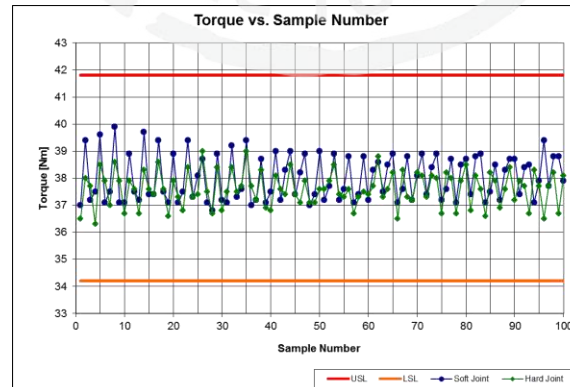
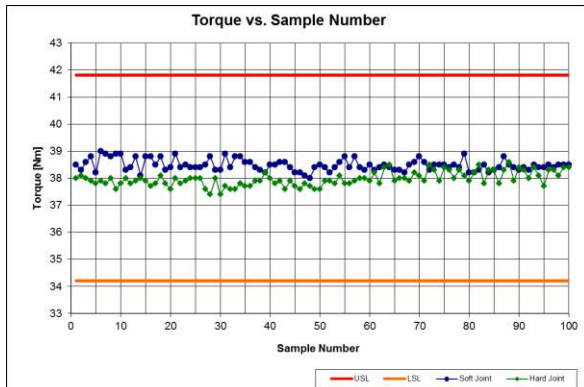

Power Train – Ergonomics and Spares Inventory



- Advanced material yield up to 50% weight reduction against competitor tools
- Common power train components across the range minimize spares requirement
- Efficient planetary design >95% maximizes torque output

Ergonomic Reverse, Grip Options and Torque Verification Port

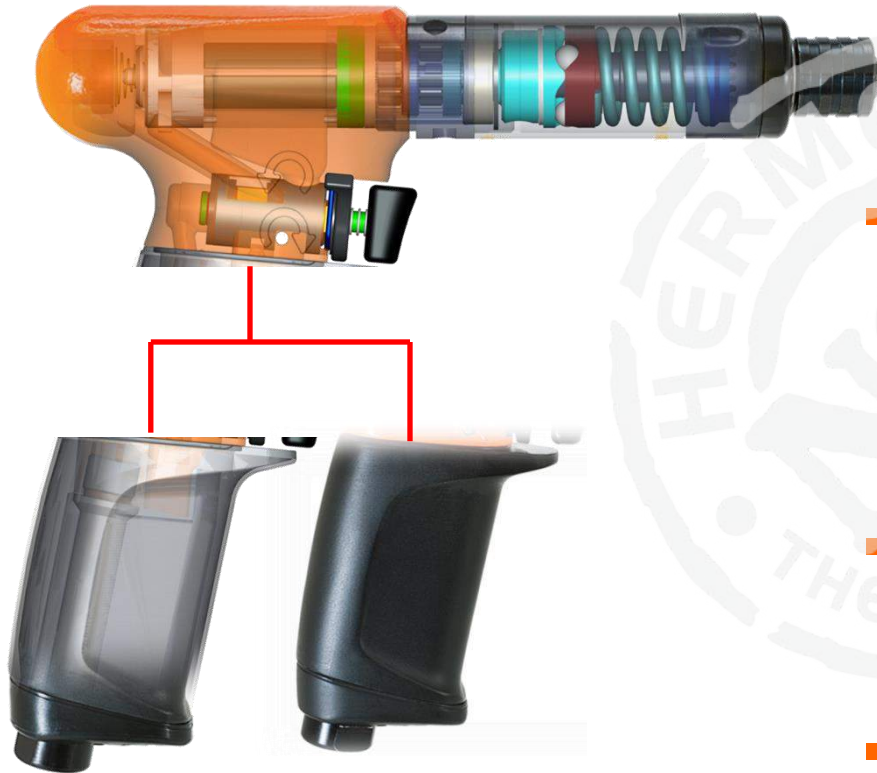

- Two interchangeable pistol grip handle sizes to customize to operator increasing operator comfort and productivity
- Soft-touch grip delivers superior protection against temperature, oil, grease, vibration, and slip meaning improved ergonomics and reduced fatigue
- Adjustable reverse lever offers true one-hand operation and adaptability for left-or-right-handed users
- Easy access torque verification port parallel to the main air line for streamlined hose management

Cleco[®]





VS

Company A

Industry-leading accuracy and repeatability	✓	
5 year warranty on auto shut-off clutch	✓	
Torque verification port as standard	✓	
2 Interchangeable handle sizes to provide comfort to a range of users	✓	
Torque Multiplier Compatibility	✓	
Over 100 variations offered, based on configuration, RPM, and torque range	✓	✓
Innovative materials yield one of the lightest weight tools on the market	✓	✓

Configurations & Options



Configuration	Shut Off Types	Torque Range	Speed Range RPM	Options
"P" Handle 	Torque Control Stall	5 ~130 in-lb 0.6 ~ 14.7 Nm ~ 40 in-lb ~ 4.5 Nm	260 ~ 2800 1100 ~ 2800	Trigger/Push to Start Specialty Heads TVP Torque Verifier
"T" Handle 	Torque Control Stall	5 ~130 in-lb 0.6 ~ 14.7 Nm ~ 40 in-lb ~ 4.5 Nm	260 ~ 2800 1100 ~ 2800	Trigger/Push to Start Specialty Heads TVP Torque Verifier
Right Angle 	Torque Control Stall	5 ~100 in-lb 0.6 ~ 11.3 Nm ~ 55 in-lb ~ 6.2 Nm	260 ~ 2800 850 ~ 1700	Specialty Heads TVP Torque Verifier Torque Multiplier
In Line 	Torque Control	5 ~130 in-lb 0.6 ~ 14.7 Nm	260 ~ 2800	Push to Start Lever/Push to start Quick change/Bit & Finder TVP Torque Verifier

Specialty heads are commonly used for applications with access challenges. Integrated with the 19 series fastening tool, we provide **Complete Fastening Solutions** for your **Aerospace Applications**.

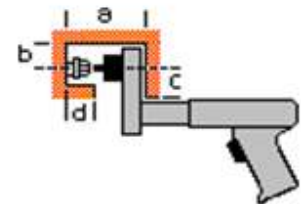
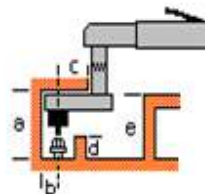
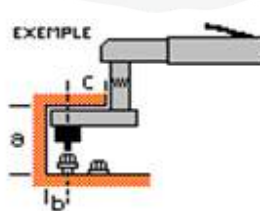
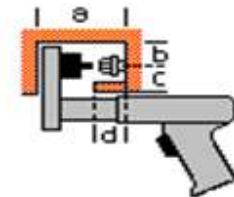
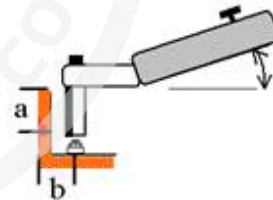
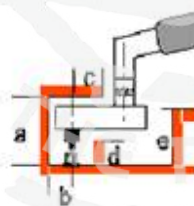



DC Tools

DC Hand Tools



Global Controller



Intelligent Spindle



Cleco mPro400GC (Global Controller)

ONE Controller for:

- Cleco Corded DC Hand Tools
- Cleco Cordless DC Hand Tools
- Cleco Cordless Intelligent Wrenches
- DGD Fixtured Multiples



Apex Modular Tightening System

Cleco®



- Single controller to multiple tool solutions
- Corded DC Electric Tools
- Cordless DC Electric Tools
- I-Wrench

The Livewire – Up to 16 Cordless Tools

Cleco[®]



LiveWire Battery Tool - Cordless Technology **Cleco**[®]

Torque Range: (5-70)Nm

- ✓ On-Board Controller
- ✓ Integrated Servo
- ✓ Intelligent Power Management



Wireless Communications

Integrated Intelligence

Brushless Motor

Scanner Option



Resolver Precision

Reaction Transducer

Infrared Comm. Standard



Audible Alarm

Lithium-Ion Technology



Traceability for Safety Critical Fastening up to 70 Nm

LiveWire Battery Tool - Live Operator Display **Cleco**[®]



- ✓ Real-time Interface
- ✓ Redundant (LCD/LED)

Feedback

- Green LCD = OK
- Green LED = OK
- Yellow LCD = Running
- Red LCD = NOK / Errors
- Red LED = NOK



**Cordless
Freedom**

or

**Tethered
Speed...**



**The Choice
Is Yours.**



vmax[™]

Livewire - Benefits



- ✓ Eliminate Cables and Cable Management
- ✓ Increase Operator Efficiency and Productivity
- ✓ Reduce In-System Damage Costs





**Cleco
Cordless**

**Cleco Cordless
LiveWire 2**

**360 grams
lighter**

- Broad Range of Torque and Tool Configuration Offerings
- Common controller for all tools
- Best-in-Class Cable Life

Corded Electric Tools In-line, Pistol, Angle Offering

- Brushless Motor Technology
- Resolver Speed / Angle Control
- Reaction Transducer
- Ergonomic Comfort Handles
- High Visibility Status LED's
- Tool Memory Chip
- Serviceable Motor Technology

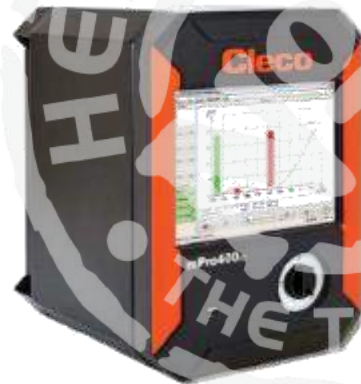

Serviceable Motor Technology

Automatic Head Recognition Feature



Color Touch Screen Navigation

- Tq. & Angle Data
- VIN used
- Application/ P-Set Selected
- Event status update

Programmable Correctional Tq/Angle Factor for Special Head Attachments



Software



- Customer Protocols
- Production Server
- Data Base

Plant Network



WLAN 2.4 & 5Ghz

Operate via -

- mPro400 GC
- PC / HMI w/ mProRemote software



Operator Guidance
Visual & Tactile

Integrated Bar Code Scanner



- Measurement of Angle of Rotation Independent from Temperature
- Rechargeable Li-Ion battery
- Operator Guidance through vibration notification

I-Wrench

- New Process Quality Assurance Product from ATG
- 2 Models of I-Wrench:
 - Production (PRW)
 - Quality (SPC)
- Quality and Productivity Focused Features
- mPro400GC Programmed
- Replacement of existing “mechanical” torque wrenches
- True angle control without fixturing
- Multiple torque targets assigned to single wrench



Productivity

- Wi-Fi Communication for Industry Leading Uptime to GC or Standalone PC program
- Integrated Scanner for Product ID
- Auto head recognition for error proofing
- Color touch screen for easy of use

Ease of Deployment

- 1.5 Nm to 1500 Nm Torque Range
- Wireless and Wired Installation
- Multiple tools to a Single Controller
- Wi-Fi and Bluetooth Wireless Communication

Ergonomic

- Operator Display for Feedback
- Li-Ion Battery (up to 9 hours of run time)
- Lighter than traditional Click style tools
- Audible, visual and tactile user feedback

I-Wrench



- Organization of quality control testing w/ SQnet
- Automatic data and trace storage for QC checks
- Process Verification & Torque Angle Validation Routing
- Trace capture and analysis of QC checks
- SPC Reporting
- CW and CCW Testing

I-Wrech: Quality Applications

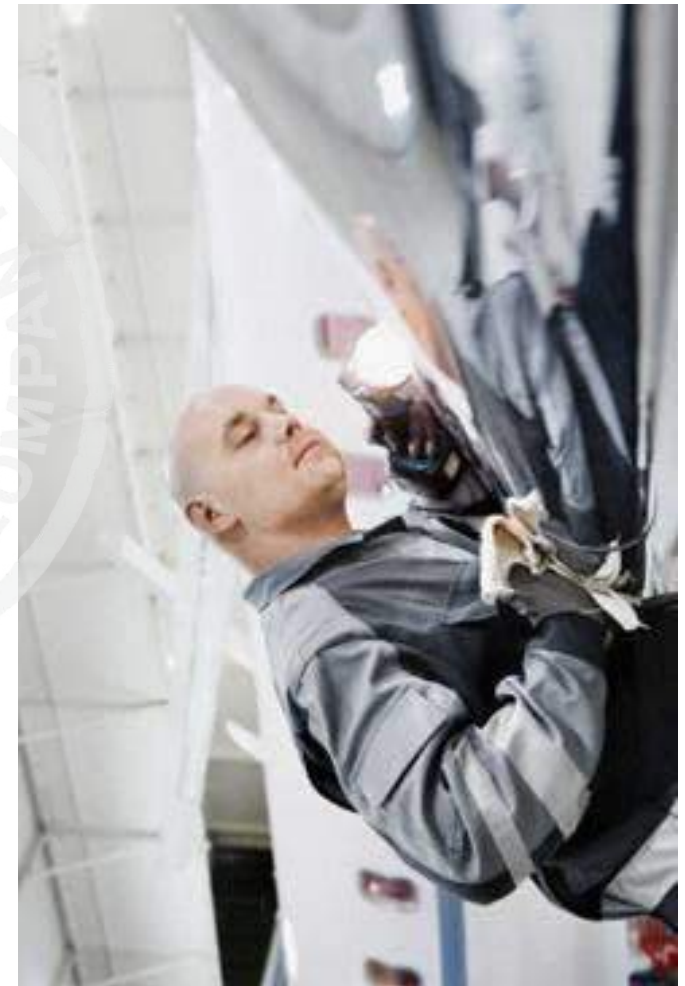

Critical and Complex Tightening

- Difficult access or limited space and complex applications
 - Brake, hydraulic, fuel lines
 - Offset applications
- Hand tool applications with requirement for HIGH torque and angle accuracy
 - Torque Control, Angle Monitoring
 - Angle Control, Torque Monitoring
- Low production or pilot builds
- Applications requiring high torque without reaction

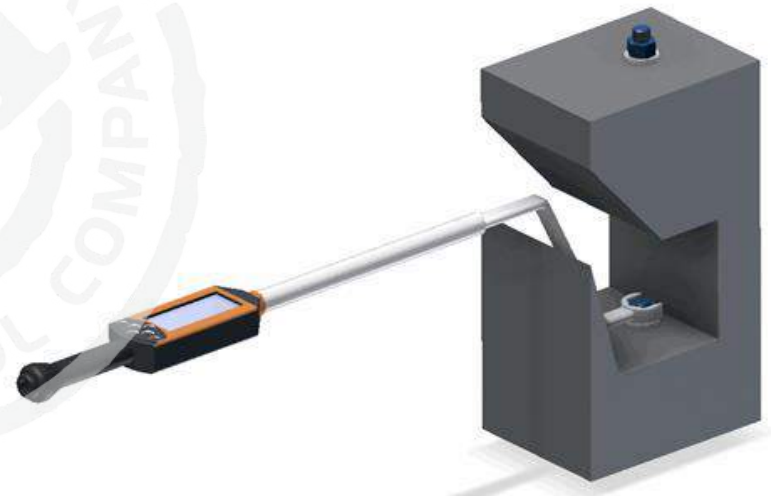

Operator Guidance

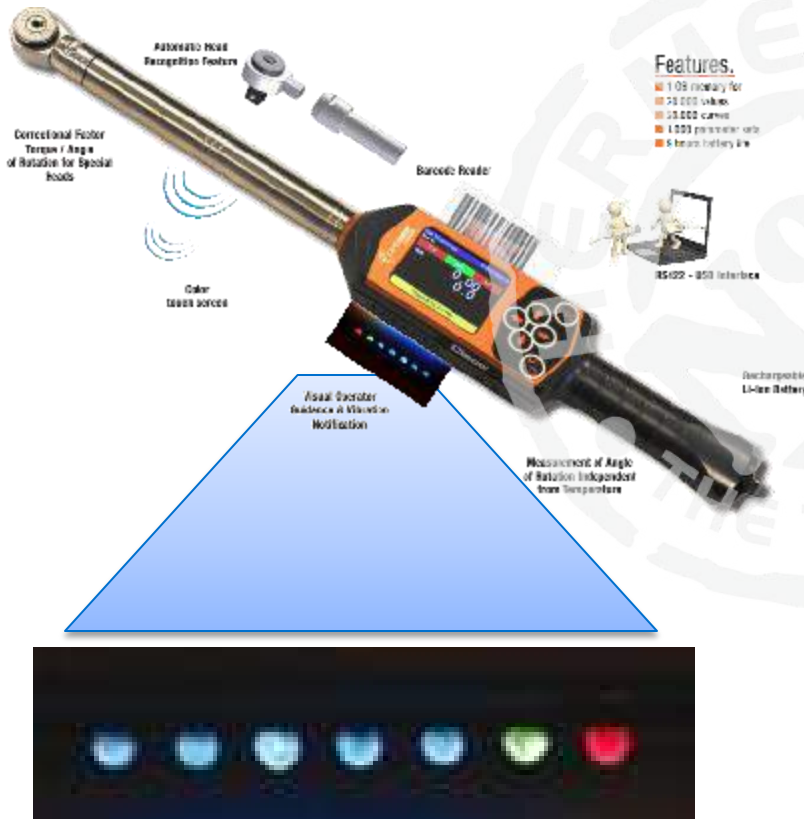

- LED progression display
- Buzzer and vibration alarm
- Alerts operator when approaching and reaching tightening targets
 - Blue LED 1 = 30%,
 - Blue LED 2 = 50%,
 - Blue LED 3 = 70%,
 - Blue LED 4 = 90%,
 - Blue LED 5 = 98% increments (configurable w/ Quality I-Wrench)
- LED target (torque/angle) signal
- LED result (OK/NOK) notification

Precision & Performance

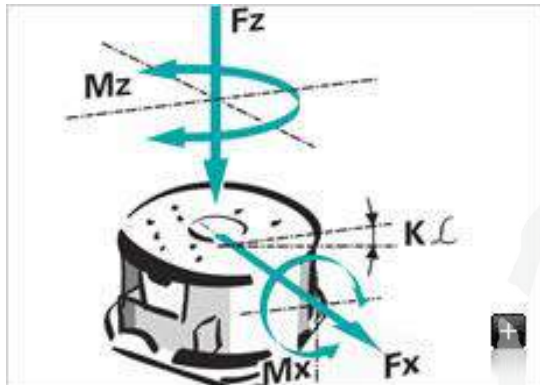

- Measurement Accuracy
 - +/- 0.5% deviation @100% torque capacity
 - +/- 1% deviation below 20% torque capacity
 - +/- 0.1° angle display deviation
- Fractional Angle Measurement
- Data Storage
 - Internal Memory: 1 GB
 - 20,000 results, 20,000 curves (traces), 1,000 applications (Quality I-Wrench)

Gyro- Based Calculation



- Strain-gauge Transducer with Dual Bridge
- Gyro, not Accelerometer
 - Higher accuracy
 - Speed-based angle calculation
- Temperature Compensation
 - Removes temperature influence on angle readings

Auto Head Recognition



- Chip supported head recognition
- Error proof process combining selected head and application
- Torque & Angle Correction Factors
- Integration with mPro400GC Controller

Head Attachments

- Quick Release Ratchet
- Ratchet Insert
- Ratchet Insert – fine tooth
- Square Drive Insert (Fixed Position)
- Bit Ratchet Insert
- Bit Holder Insert



Open End Head Attachments

- Open End Insert
- Open Ring Insert
- Ring Insert
- Extended Ring Insert
- TORX Insert



Available Head Attachments – “Specials”

- Outer Drive 14x18 / Internal Drive 9x12mm
- Outer Drive 9x12 / Internal Drive 14x18mm
- Outer Drive 24.5x28 / Internal Drive 14x18mm
- Lateral Dovetail Profile / Internal Drive 9x12 or 14x18mm
- Blank End Insert - Customization



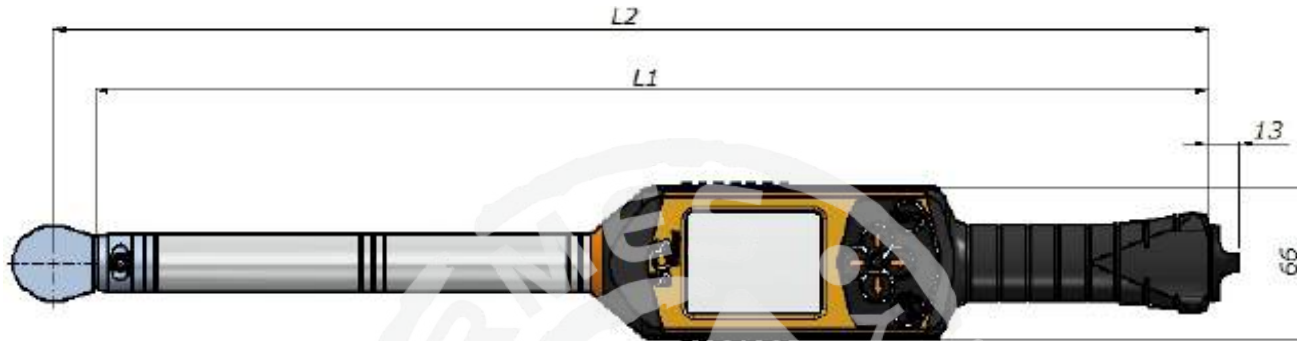

Torque Capacity (Nm)	Connection (end- Fitting)	L1 (mm)	L2 (mm)	Weight *
15	9x12 Female	375	393	0,8
30	9x12 Female	375	393	0,86
70	9x12 Female	480	498	0,93
100	9x12 Female	480	498	0,93
200	14x18 Female	604	629	1,5
300	14x18 Female	754	779	1,86
400	14x18 Female	854	879	2
600	14x18 Female	1032	1057	3,65
800	Ø 20	1250	1330	5,1
1000	Ø 20	1530	1610	6,25

* Listed weight w/o ratchet head



Productivity

- Wi-Fi Communication for Industry Leading Uptime to GC or Standalone PC program
- Integrated Scanner for Product ID
- Auto head recognition for error proofing
- Color touch screen for easy of use

Ease of Deployment

- 1.5 Nm to 1500 Nm Torque Range
- Wireless and Wired Installation
- Multiple tools to a Single Controller
- Wi-Fi and Bluetooth Wireless Communication

Ergonomic

- Operator Display for Feedback
- Li-Ion Battery (up to 9 hours of run time)
- Lighter than traditional Click style tools
- Audible, visual and tactile user feedback

I-Wrench Cordless Productivity

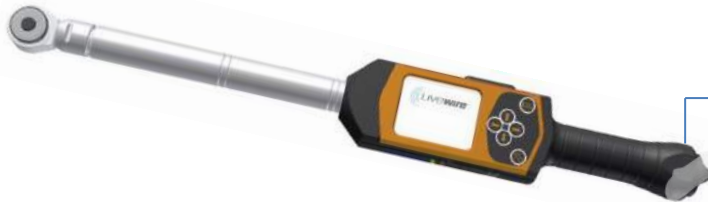

Download data results and
Traces/curves to GC



LiveWire I-Wrench is torque/angle wrench designed to be programmed by the mPro400GC

- One common platform for programming
- Easy to program (application setup like other Cleco DC hand tools)
- For every tightening program LiveWire I-Wrench saves the results and curves/traces directly to the mPro400GC (>10,000 per wrench at GC)
- High Torque Accuracy w/ dual bridge strain gauge (non length dependent)
- High Angle Accuracy with Gyroscope (w/ Temperature Compensation)
- Operator Guidance – Visual & Vibration Notification
- Color Display Screen (Touch)
- Wi-Fi connection to mPro400GC (supports 2.4 & 5 GHz)
- Connect up to 16 LiveWire tools to mPro400GC (I-Wrench and LW Power Tools)
- No extra hardware to unlock features



- Torque Range : 2 – 2800 NM
- Patented Single-Cable Design
- Compact on-board intelligence
- Modular Construction – Ultimate Versatility



- High Productivity
- World class durability (MTBF 3 Mil cycles @80%)
- World class accuracy (Cmk >1.67 @ +/- 5%)

- Over 25,000 nutrunners installed
- European Homologation Compliance
- Complete product portfolio
- Proven lower cost of ownership

On-Board Servo
Module

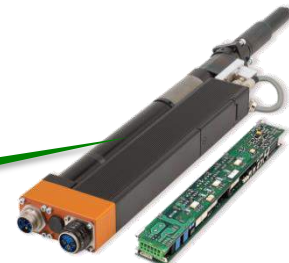

Easy Access, Compact Flash, <1 Minute Boot



- Low Mean Time To Repair
 - CF (Compact Flash) – allows installation of complete operating software including application parameters
 - Rapid Controller Swap
 - Boot Time Less than 1 Minute
- Serviceability
 - Ease of Access
 - Ease of Troubleshooting
 - Full Cover Removal for Bench Repair

Software / Hardware Supports All Customer Protocols

- Cooper
 - Standard/ Standard Plus – Serial / Ethernet
- TorqueNet
 - Data Server - Ethernet
- Daimler MBUSI
 - Click/Plus*
- Chrysler
 - PFCS – Serial / Ethernet / Fixtured Bundling
- Volkswagen
 - XML – Ethernet – Open Protocol*
- General Motors
 - Common Controller (Rev. J) – Q4-2010
 - GM Powertrain Gen V - Q4-2010
 - Q-DAS Statistical Package - Complete
- BMW
 - Kiss Q*
- Harley Davidson
 - AVIS/WIN-SPC – Serial/Ethernet

*available with special application software versions



- Apex produces the industry's largest selection of industrial fastening tools:
 - Bits, Bit Holders, Sockets, Nutsetters, Extensions, Adapters, Anti-mar products, and Custom Solution Specialty Fastening Tools



**U-Guard
Safety and
Anti-Mar
Products**

- 80 Years of production and product experience.
- World's leader in providing Custom Solution Specialty tools for the fastening industry.
- Known for breadth of selection, superior industrial performance, lower total cost of ownership and unmatched quality.
- Apex branded fastening tools have over a 80% share of business in the BRP Sturtevant plant with most spinning tools covered in U-Guard.
- Growing presence in other North American plants.

Process
Quality Assurance
Solutions by
APEX Tool Group



Dynamic Fastening System



- Repair Bays
- Pilot Build
- Mobile “crash” cart
- Online production build of new models
- Cellular Build

DFS: Mobile, Programmable, Fastening System

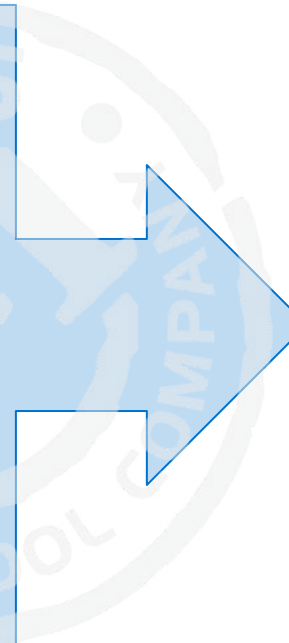
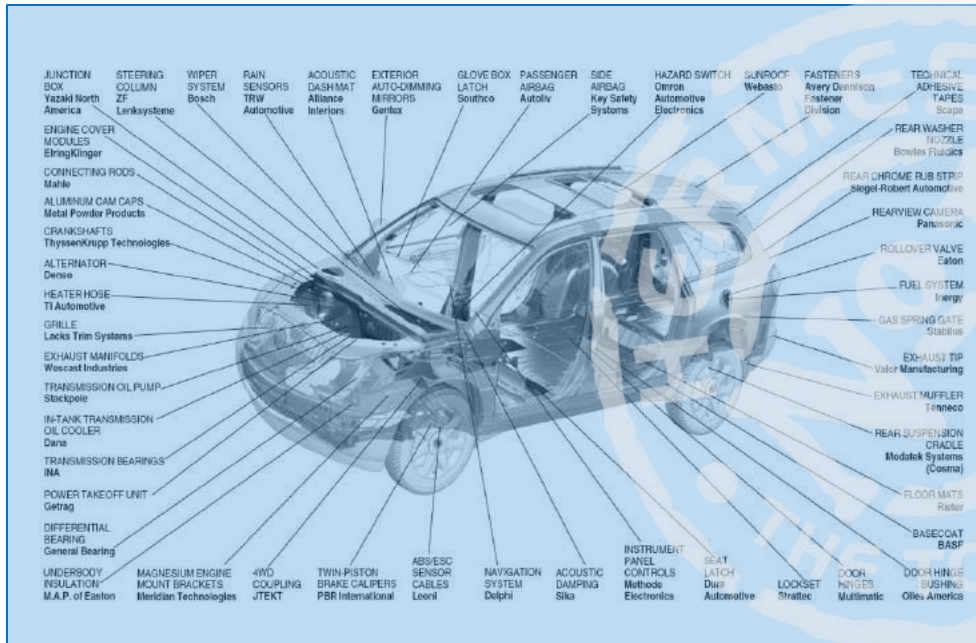

All assembly applications in a central location
 Battery Powered (8+ hours)
 DFS cart has preformed over 700 tightening stations in the
 field

Data Transfer & Process Control



Option 1: Manual Operation

Data Server

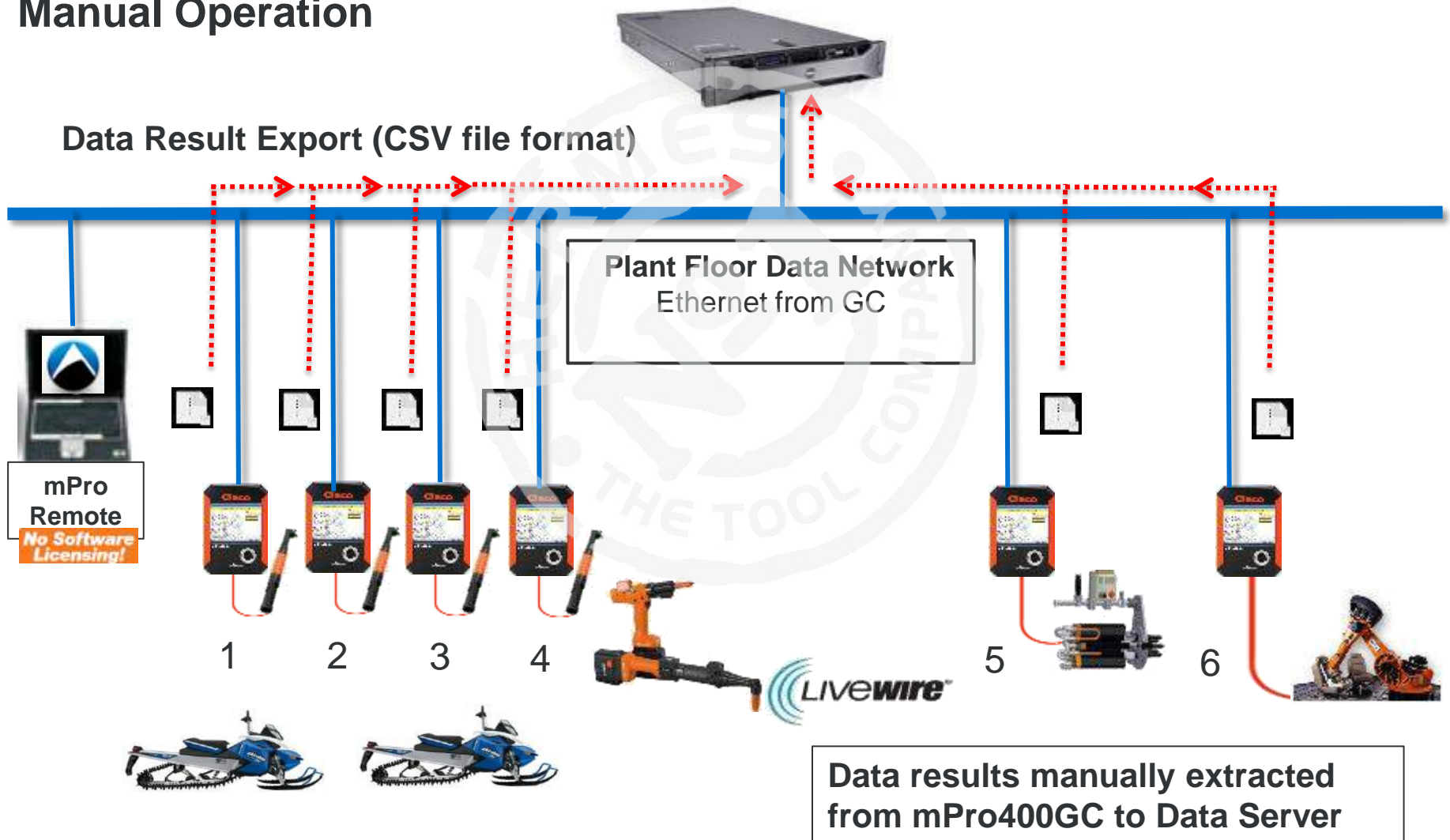

Overall Hardware / Software Architecture



Option 2: Automated Operation

TorqueNet Server

Data Server



Rundown & Trace Archive
w/Reporting

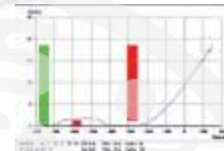

Plant Floor Data Network
Ethernet from GC



Data from controller sent via mPro400GC
file format after each rundown

Overall Hardware / Software Architecture



Option 3: Automated Operation

Data Server

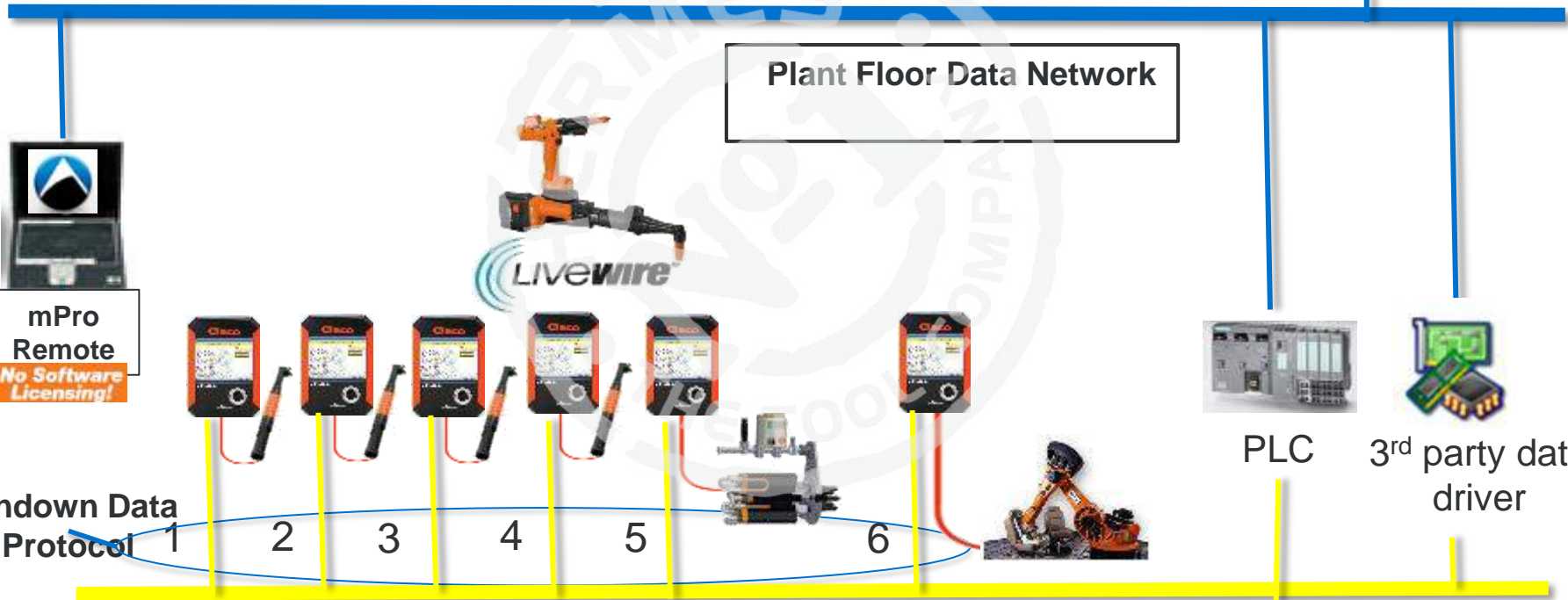

Ethernet from GC or Ethernet from field bus

Full Line of Error Proofing Offerings



■ Communication medium

- Line PLC
- Discrete
- Devices
- Light stack
- Active Line stops
- Socket Trays

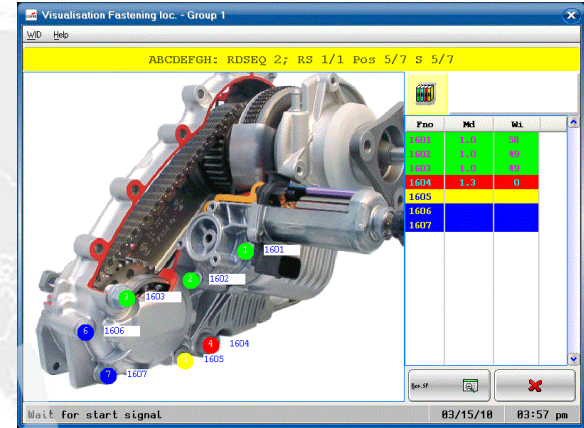

Digital
Process
Error Proofing



TorqueNet Data – Simple view

Search Result (27 values)

Controller	Ident.-No.	Addition	Grp	Sp	Stp	JNo	App	Stg	SEQ	TQact	ANact	GDact	Error	Code	Tool Serial#	Date / Time	Details
VIM351			1	1	1	0	1	2	50	0.00	100				R14849	6/20/2011 9:20:49 AM	
Anton SE		OFFLINE PG01	2	2	1		1	3	50	0.23	51				657600	6/20/2011 10:50:49 AM	
Anton SE		OFFLINE PG01	2	3	1		1	3	50	0.00	50				657600	6/20/2011 10:50:49 AM	
Anton SE		OFFLINE PG01	2	2	1		1	3	50	0.12	51				657600	6/20/2011 10:50:52 AM	
Anton SE		OFFLINE PG01	2	3	1		1	3	50	-0.02	50				657600	6/20/2011 10:50:52 AM	
Anton SE		OFFLINE PG01	2	2	1		1	3	50	0.12	51				657600	6/20/2011 10:51:03 AM	
Anton SE		OFFLINE PG01	2	3	1		1	3	50	0.00	50				657600	6/20/2011 10:51:03 AM	
Anton SE	AI110620105454		2	2	1	121001	1	3	50	0.12	51				657600	6/20/2011 10:55:03 AM	
Anton SE	AI110620105454		2	3	1	122001									657600	6/20/2011 10:55:03 AM	
Anton SE	AI110620105454		2	2	2	221001	1	3	50	0.23	51				657600	6/20/2011 10:55:10 AM	
Anton SE	AI110620105454		2	3	2	222001	1	3	50	0.05	50				657600	6/20/2011 10:55:10 AM	
Anton SE	AI110620105510		2	2	1		1	3	50	-0.03	50				657600	6/20/2011 10:55:13 AM	
Anton SE	AI110620105510		2	3	1	122001	1	3	50	-0.03	50				657600	6/20/2011 10:55:13 AM	
Anton SE	AI110620105510		2	2	2	221001	1	3	50	0.12	51				657600	6/20/2011 10:55:16 AM	

Tool / Spindle Serial Number

Event Details

Application Details

Operation / Application Name

Controller Name

Date & Time Stamp

Tightening Traces

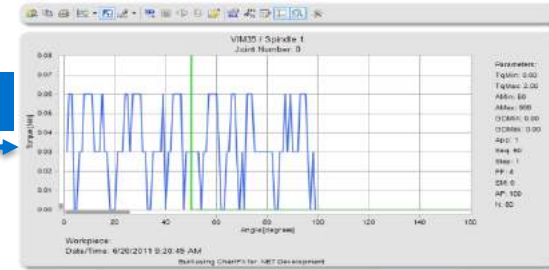

Controller: VIM35	Total: 35	OK: 35	NOK: 0											
Date/Time: 6/20/2011 9:20:49 AM	Workpiece:	App: 1	Sp: 1 Grp: 1 St: 1											
Step	JNo	App	Stg	SEQ	TP	Tq(Nm)	Tq-OT	Ang(deg)	A-OT	GD	GD-OT	Time	Error	Code
1	0	1	1	11	0.00	0.03						9:20:49 AM		
1	0	1	2	50	100.00	0.00		100				9:20:49 AM		

Tightening Details / Data

Stage	Error	Code	Meaning
Controller: VIM35		App: 1	Sp: 1 Grp: 1
Stage 1			
Sequence	11		
Trigger moment	0,00 (Nm)	Speed	40 (1/min)
Shut off torque	0,00 (Nm)	Damping factor	1
Stage 2			
Sequence	50		
Trigger moment	0,00 (Nm)	Speed	60 (1/min)
Threshold moment	0,00 (Nm)	Damping factor	4
		Shut off angle	100 (grd)
Minimum moment	0,00 (Nm)	Minimum angle	50 (grd)
Maximum moment	2,00 (Nm)	Maximum angle	999 (grd)

Last 25 Rundowns Detail

Every thing you want or need to see is but only a mouse click away to drill down into data and status's of your fastening operations

Controller: ENT/Anton		Total: 49	OK: 45	NOK: 4										
Date/Time: 9/8/2011 10:40:55 AM	Workpiece: 12345678	App: 1	Sp: 1	Grp: 1										
Step	JNo	App	Stg	SEQ	TP	Tq(Nm)	Tq-OT	Ang(deg)	A-OT	GD	GD-OT	Time	Error	Code
4	104	1	4	50	50.00	1.10		50				10:40:55 AM		

Tightenings for Workpiece.: **12345678**

Controller	Ident.-No.	Addition	Grp	Sp	Stp	JNo	App	Stg	SEQ	TQact	ANact	GDact	Error	Code	Tool Serial#	Date / Time	Details
VIM351	12345678		2	2	1	3301	1	2	50	0.00	101				662313	7/20/2011 2:30:33 PM	
VIM351	12345678		2	2	2	3302	1	2	50	0.00	101				662313	7/20/2011 2:30:35 PM	
VIM351	12345678		2	2	1	3301	1	2	50	0.00	101				662313	7/20/2011 2:37:31 PM	
VIM351	12345678		2	2	2	3302	1	2	50	0.00	101				662313	7/20/2011 2:37:34 PM	
VIM351	12345678		2	2	1	3301	1	2	50	0.01	101				662313	7/20/2011 2:38:29 PM	

Click on the spindle icon

Tightening Curve

Stage	Error	Code	Meaning

Controller: ENT/Anton	App: 1	Sp: 1	Grp: 1
-----------------------	--------	-------	--------

Stage 4

Sequence			
Trigger moment	50	Speed	20 (1/min)
Threshold moment	0.00 (Nm)	Damping factor	4
Minimum moment	0.00 (Nm)	Shut off angle	50 (grd)
Maximum moment	5.00 (Nm)	Minimum angle	20 (grd)
		Maximum angle	80 (grd)

Click on the tightening data icon

Ident.-No.	Addition	JNo	Sp	Stp	App	Stg	SEQ	TQact	ANact	GDact	Error	Code	Tool Serial#	Date / Time	Details
12345678		104	1	4	1	4	50	1.10	50					9/8/2011 10:40:55 AM	
12345678		103	1	3	1	4	50	1.28	50					9/8/2011 10:40:53 AM	
12345678		102	1	2	1	4	50	0.78	50					9/8/2011 10:40:52 AM	
12345678		101	1	1	1	4	50	0.82	50					9/8/2011 10:40:51 AM	
12345689		104	1	4	1	4	50	0.91	50					9/8/2011 10:27:19 AM	
12345689		103	1	3	1	4	50	1.14	50					9/8/2011 10:27:17 AM	
12345689		102	1	2	1	4	50	1.79	50					9/8/2011 10:27:15 AM	
12345689		101	1	1	1	4	50	0.64	50					9/8/2011 10:27:14 AM	
12345688		104	1	4	1	4	50	0.96	50					9/8/2011 10:17:37 AM	
12345688		104	1	4	1	4	50	0.32	3		SA	002		9/8/2011 10:17:30 AM	
12345688		103	1	3	1	4	50	0.78	50					9/8/2011 10:17:28 AM	
12345688		102	1	2	1	4	50	0.41	11		SA	002		9/8/2011 10:17:25 AM	
12345688		101	1	1	1	4	50	0.45	11		SA	002		9/8/2011 10:17:22 AM	
12345687		104	1	4	1	4	50	0.78	50					9/8/2011 10:16:41 AM	
12345687		103	1	3	1	4	50	0.82	50					9/8/2011 10:16:39 AM	
12345687		102	1	2	1	4	50	0.91	50					9/8/2011 10:16:36 AM	
12345687		101	1	1	1	4	50	1.14	50					9/8/2011 10:16:33 AM	
12345686		104	1	4	1	4	50	1.79	50					9/8/2011 10:14:15 AM	
12345686		103	1	3	1	4	50	0.64	50					9/8/2011 10:14:11 AM	
12345686		102	1	2	1	4	50	0.96	50					9/8/2011 10:14:06 AM	
12345686		101	1	1	1	4	50	0.41	50					9/8/2011 10:14:02 AM	
12345684		104	1	4	1	4	50	1.70	50					9/8/2011 10:06:42 AM	
12345684		103	1	3	1	4	50	1.10	50					9/8/2011 10:06:40 AM	
12345684		102	1	2	1	4	50							10:06:38 AM	
12345684		101	1	1	1	4	50							10:06:36 AM	

Click on the trace icon

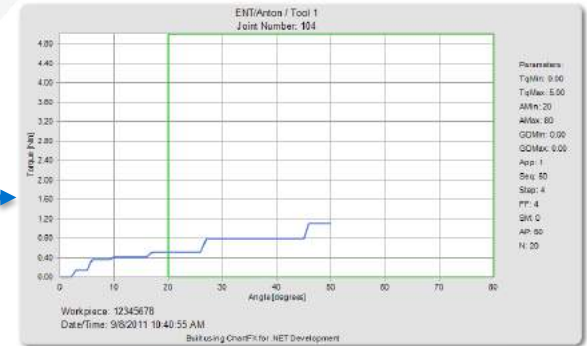

NOK rundowns are hi-lighted in RED for quick visualization

Statistics Set Up Screen

TorqueNet

Generate statistics

From: 6/13/2011 2:30 PM

Until: 6/20/2011 2:30 PM

Controller: Anton/804

Statistics: NOK Statistics by Joint Numbers

Add. Identity no.:

JNo: 121001

App:

Group: 2

Spindle: All

Step: All

Calculate Statistics

Include "No evaluation":

Error:

Error code:

Stage evaluation: Shut off stage

Calculation in %:

Apply Stage Filter to Stage Statistics:

Note the statistics options, by Job, by Application, by Group, by Spindle and by Step. Statistics by Step is unique to TorqueNet

Statistical charts, simply created with Chart FX package Build to choice

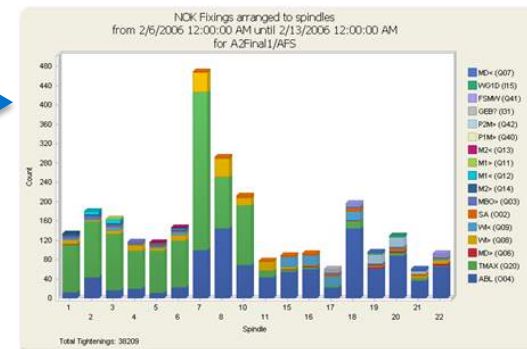
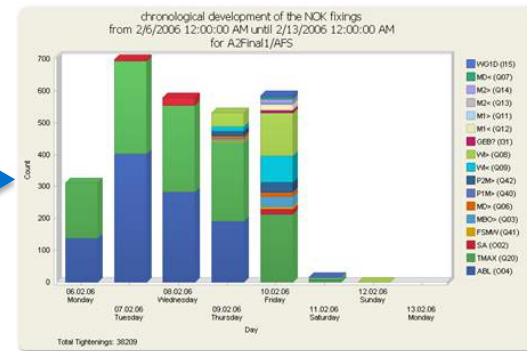
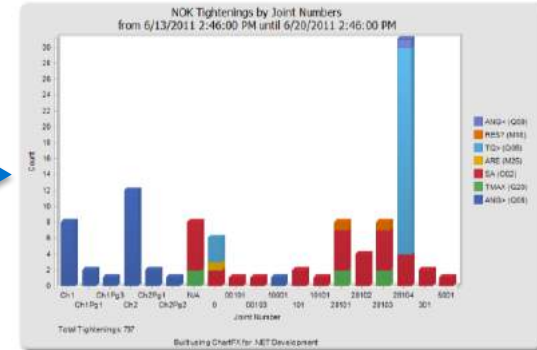

Process Statistics

Controller	Grp	App	JNo	Parameters				Torque [Nm]				Angle [degrees]				Count	OK	NOK	% NOK					
				ID	Min	Max	Min	Max	Ø	Cr	Cp	Cpk	Min	Max	Ø					Cr	Cp	Cpk	Min	Max
Anton/804	2	1	N/A	347	0	5	0	100	0,08	8,45	2,36	0,25	0,0166	0,2344	50,50	30,43	3,29	30,12	50	51	6	6	0	0
VIM35	1	1	0	346	0	2	50	999	0				0	0	100	100	100			1	1	0	0	
Anton/804	1	1	10001	349	10	15	10	900	11,57	0,74	2,93	0,46	9,88	12,18	666,75	0,87	2,51	0,46	495	901	4	3	1	25
Anton/804	1	1	10002	349	10	15	10	900	12,03	72,17	3,46	58,70	12,02	12,04	578,33	1,48	3	1,07	477	678	3	3	0	0
Anton/804	2	1	121001	350	0	5	0	100	0,12				0,1172	0,1172	51				51	51	1	1	0	0
Anton/804	2	1	121001	347	0	5	0	100	0,12	11785,11	4,24	552,72	0,1172	0,1173	51				51	51	2	2	0	0
Anton/804	2	1	122001	350	0	5	0	100	-0,02				0,0166	0,0166	50				50	50	1	1	0	0
Ani									-0,02	70,99	4,24	-0,71	0,0332	0,0166	50				50	50	2	2	0	0
Ani									12,18	4,08	3,23	3,55	12,03	12,41	598,33	1,07	3,44	0,73	439	680	3	3	0	0
Ani									0,18	10,06	4,24	0,71	0,1172	0,2344	51				51	51	2	2	0	0
Anton/804	2	1	122001	347	0	5	0	100	0,03	35,50	4,24	0,47	0,0166	0,0498	50				50	50	2	2	0	0

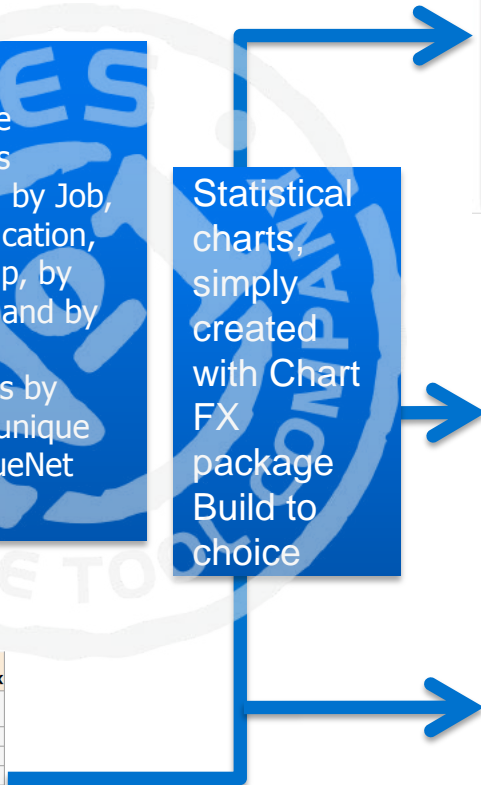

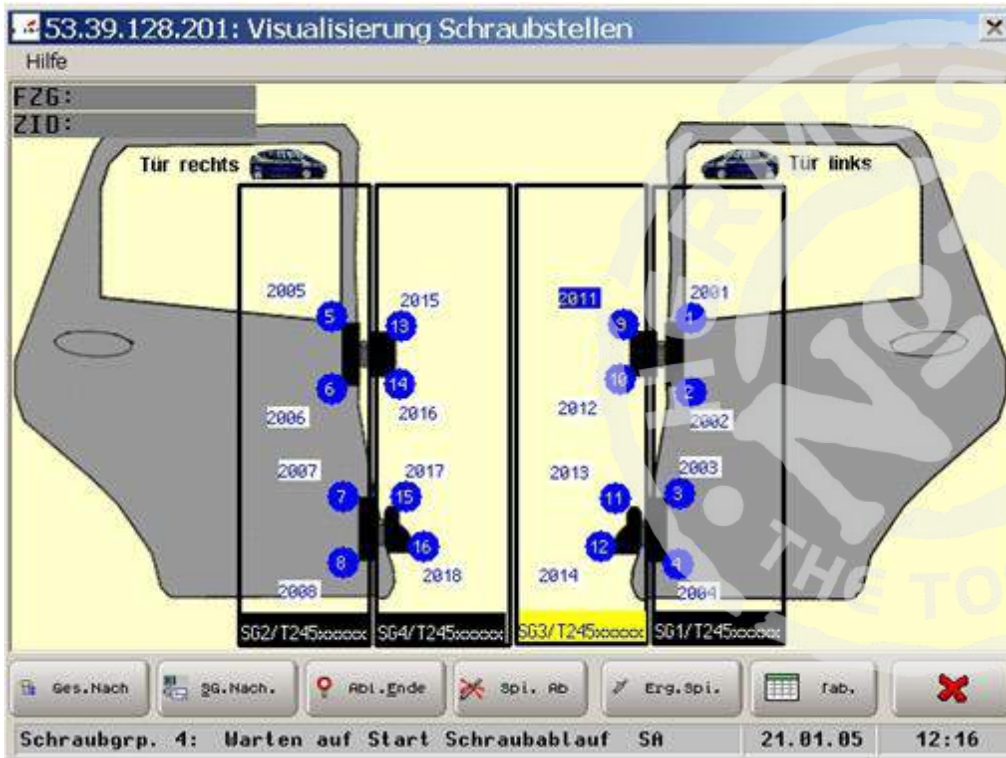

Process Visualization

- User defined
- Load an image of the application / assembly
- See / follow the tightening sequence
- Enables operator guidance capabilities
- Enables Production & Manufacturing engineering the ability to monitor process efficiency

Tool Maintenance Advisory

- Can be user defined
- Or system defined
- Enables greater uptime / availability of product where it belongs, on the assembly line.
- Delivers best (TCO) Total Cost of Ownership

TorqueNet

Controller	Location Description	Channel	Tool SerNr	STATE	Tool type	As of	Total No. of rundowns	Maintenance Counter	Rundowns since Service	Rundowns until Service	Last Service	Maintenance State	Details
Test S16804	235	3	53479	176,9%	2BB-2B150A-2K2M-2ZA-v	14.06.2011 13:19:02	1330371	230	1330371	-100		Send for maintenance	
Test S16804	235	4	*****	116%	*****	14.06.2011 13:19:02	1090589	232	1090589	-32		Send for maintenance	
Test S16804	235	1	654105	99,8%	1BB-1B030A-1K1M-1ZA	14.06.2011 13:19:02	1304624	49610	1304624	90		Warning before maintenance	
Test S16804	235	2	654102	38,8%	1BB-1B030A-1K1M-1ZA	14.06.2011 13:19:02	1141403	442	1141403	698			
Anton SE	Anton/804	2	0815	0,3%	2BUA1702KV2	20.06.2011 14:53:43	219881	1682	219881	498318			
Anton SE	Anton/804	3	8543668	0,1%	17EA22AM3	20.06.2011 14:53:43	15604	383	15604	499617	06.07.2009		
4 HL2 Cockpitmontage	Anton/SE_186	1	657600	0,1%	2BUB-2B150A-2K2M-2VK2M	20.06.2011 07:44:04	102552	2157	102552	2997843			
4 HL2 Cockpitmontage	Anton/SE_186	4	649042	0%	1BB-1B050A-2/1K2M-1ZA	20.06.2011 07:44:04	48016	254	48016	2999746			